





**APLAST**  
ROTOMOULDED  
PIPING | TOOLING

# Production program for polyethylene pipes





# TABLE OF CONTENTS

 PE PIPES FOR DISTRIBUTION OF DRINKING WATER	10
 PE PIPES WITH PROTECTIVE SHEATH	14
 PE PIPES FOR SEWERAGE	18
 PE PIPES FOR GAS DISTRIBUTION	22



# LOCATION



## HEADQUARTERS

### APLAST D. O. O.

Petrovče 115a  
3301 Petrovče  
Slovenia, EU

T: +386 (0)3 713 24 50

F: +386 (0)3 713 24 54

N 46°14'32.8" E 15°11'18.4"

## MANUFACTURING PLANT LOŽNICA PRI ŽALCU

Ložnica pri Žalcu 37  
3310 Žalec  
Slovenia, EU

T: +386 (0)3 71 36 200

F: +386 (0)3 71 36 202

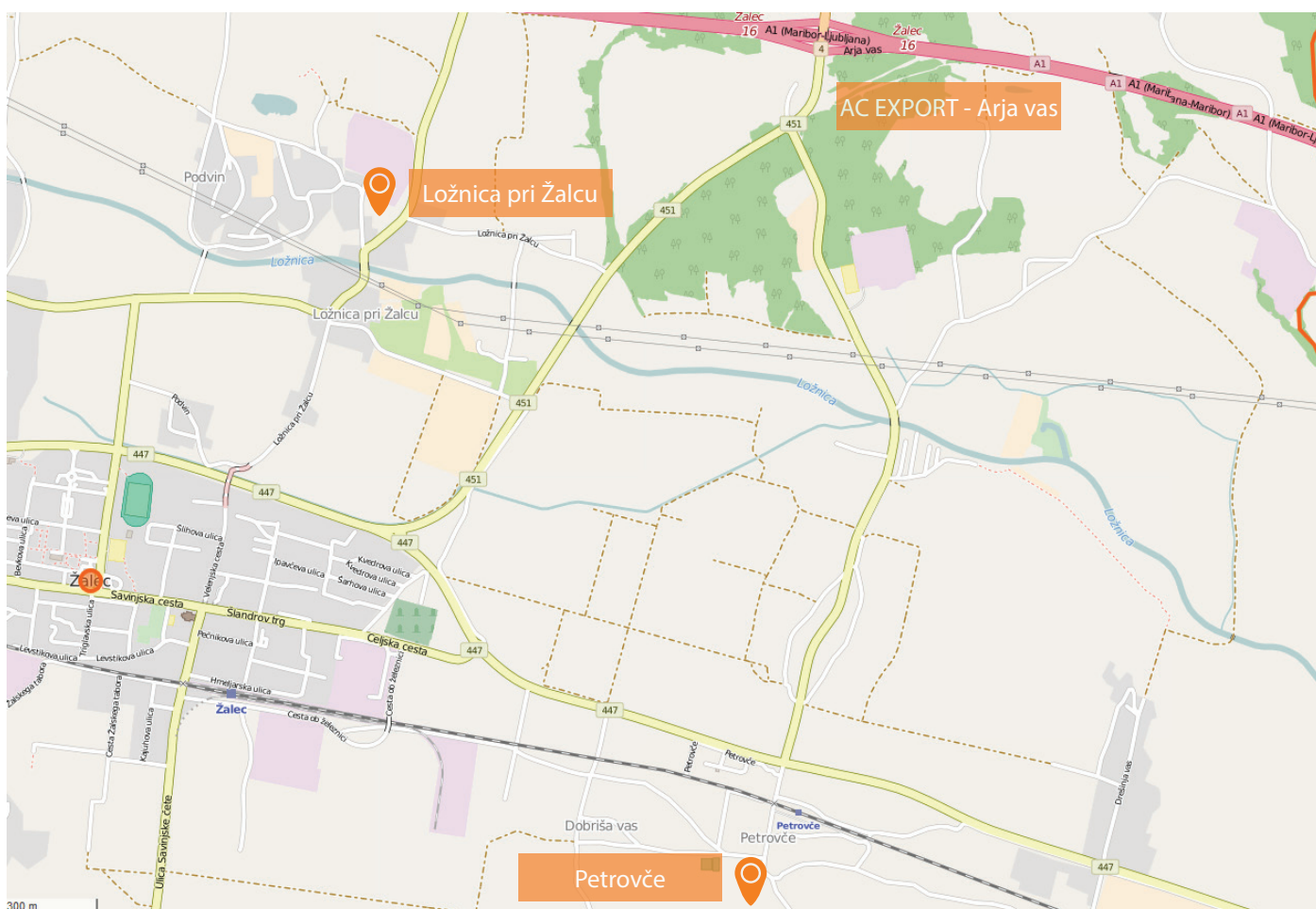



# HISTORY

The beginning of activities for production of PVC and PE pipes date back to 1968, when at the site of a former mine in Zabukovica, the company Minerva was founded. The company has intensively developed and diversified its production programme over the years.

In the first decade of operation, the company has already successfully proved itself as a leading manufacturer in Slovenia and former Yugoslavia as well. The production and thereby the number of employees in the first ten years sharply increased, so that by 1978 there were already 186 workers employed at Minerva.

In the second half of the 1980s, the supply of pipes for gas pipelines to the largest gas distributors in the entire Yugoslavia started. Selling high quality and cost competitive programme was implemented in the entire market of former Yugoslavia and the European Union markets as well.

By 2005, the sales programme expanded to water supply system, sewage, gas line, protection, irrigation, drainage, road construction, landfills and other infrastructure. In 2008 the company moved to a new location at Ložnica near Žalec with 40,000 m<sup>2</sup> of total area for manufacturing and storage, where it produced an average of 1,500 tons of PE products and 1,600 tons of PVC products. The new facilities, the additional investments in fixed assets and the increase in the number of employees, caused a dramatic development of the company.

By 2016, the company Aplast Ltd. became the universal legal successor of Minerva. With the purchase of fixed assets of the former Minerva and the new development forces, as well as our own experience in the field of designing PE and PP materials, we have laid solid foundations to the existing tradition and high-quality production programme.

With renewed vigour and fresh knowledge, in addition to the existing production lines and existing staff we have enriched the product range and quality of products with new technologies and modern equipment.

As part of the production programme we have introduced the use of the latest standards and new materials. That is why we can offer the manufacturing of products from polyethylene and polypropylene.

## MILESTONES

1968 - establishment of the company

1978 - more than 180 employees

1986 - the leading manufacturer of PE / PVC pipes in Yugoslavia

2008 - new location at Ložnica near Žalec

2016 - new owner at the site of the former Minerva joint stock company and Aplast Ltd.







# CERTIFICATES

## ISO 9001 - QUALITY

We provide high quality products in accordance with ISO 9001. Regular quality controls of products have provided us with satisfied customers. We take into account the requirements of ISO 9001:2008, the introduction of which has brought the systemic thinking and the determination to our company that all products shall be manufactured at the highest level of quality. The products are properly labelled and packed.

## ISO 14001 – PROTECTION OF THE ENVIRONMENT

In Aplast Ltd. we guarantee high responsibility regarding the protection of the environment, as confirmed by the certificate ISO 14001.

We recognize the importance of preserving the environment and the control of operating costs as well as the quality of the planned frameworks. We strive to reduce the consumption of natural resources and environmental pollution. We properly take care of the waste management and operate in accordance with applicable legislation.

# QUALITY CONTROL

Through continuous control of raw materials and process development as well as production in accordance with the most demanding international standards, we guarantee the highest level of product quality.

We have completely equipped laboratories, professional staff and quality assurance system.

Further assurance of superior quality and safety of our products is due to the additional external professional supervision of accredited laboratories.



## CERTIFICATES AND AGREEMENTS

ISO 9001

ISO 14001

STS-16/0010



<b>Zavod za gradbeništvo Slovenije</b> Slovenian National Building and Civil Engineering Institute Dimičeva 12 1000 Ljubljana, Slovenija Tel.: +386 (0)1-280 44 72, 280 45 37 Fax: +386 (0)1-280 44 84 E-pošta: info.ta@zag.si http://www.zag.si		
ozn.: S-01483/16		
<b>Slovensko tehnično soglasje STS-16/0010</b> Slovenian Technical Approval		
Podjeljeno na podlagi določil Zakona o gradbenih proizvodih – ZGPro-1 (Ur. list RS, št. 82/2013) naslednjemu gradbenemu proizvodu: On the basis of provisions of the Construction Products Act – ZGPro-1 (OG RS, nos. 82/2013) granted to the following construction product:		
Komercialno ime proizvoda:	PE cevi Aplast za oskrbo s pitno vodo, tlačno in vakuumsko kanalizacijo, oplačene PE cevi Aplast za oskrbo s pitno vodo in tlačno kanalizacijo	
Trade name	PE pipes Aplast for water supply, pressure and vacuum sewerage. Coated PE pipes Aplast for drinking water and pressure sewerage	
Imetnik soglasja: Holder of approval	Aplast d.o.o. Petrovče 115a 3301 Petrovče	
Vrsta in predvideni namen uporabe proizvoda:	Cevi iz polietilena za oskrbo s pitno vodo, tlačno in vakuumsko kanalizacijo DN 20-630 mm. Cevi iz polietilena z dodatno zaščitno plastjo izdelano iz polipropilena in polietilena za oskrbo s pitno vodo, tlačno kanalizacijo DN 32-125 mm	
Generic type and use of the product	Polyethylene pipes for drinking water supply, pressure and vacuum sewerage from DN 20 mm to DN 630 mm. Polyethylene pipes with an polypropylene made protective layer and polyethylene for water supply and pressure sewerage of DN 32 mm to DN 125 mm	
Veljavnost: Validity	od (from) 18. 07. 2016 do (to) 17. 07. 2021	
Proizvodni obrat: Manufacturing plant	Aplast d.o.o., obrat Ložnica pri Žalcu 37 3310 Žalec	
To Slovensko tehnično soglasje obsega: This Slovenian Technical Approval contains	26 strani z vključno 6 prilogami 26 pages including 6 annexes	
Obr. P.U.10.001.7/8		



 PE PIPES FOR DISTRIBUTION OF DRINKING WATER



# PE PIPES FOR DISTRIBUTION OF DRINKING WATER

## APPLICATION

Polyethylene has been used to make pipes for over 60 years mainly in the distribution of drinking water and gas as well as in the systems for the discharge of wastewater. In addition to corrosion and broad chemical resistance, the resistance to mechanical abrasion and low weight, the pipes made of polyethylene excel further with the flexibility and time durability as well.

## STANDARDS

PE pipes for the distribution of drinking water are produced in accordance with the DIN EN 12201 standard and the Slovenian technical approval STS-16/0010, issued by the Construction Institute of Slovenia. The pipes are manufactured according to the law regarding the health suitability of food and products as well as the materials that come into contact with food. For these, we also have the appropriate W 270 certificate. Polyethylene pipes for potable water are marked with a blue stripe.

## CHARACTERISTICS AND CLASSIFICATION OF PE MATERIALS (PE 80, PE 100, PE 100 RC<sup>PLUS</sup>)

According to the new ISO classification (ISO TR 9080, ISO 12162), we classify the PE pipe material for a minimum long-term strength (IAS), which is obtained by using the standard methods of extrapolation. In Table 1, the value of IAS and  $\sigma_s$  for individual types of PE material are given.

## ADVANTAGES

Welded polyethylene pipes are permanently tight tubular rods. When welded along with the coupling parts, we get permanently tight pipe systems with which we can achieve maximum operational safety. The flexibility of PE pipes allows rational techniques of installation and thus reduces costs. In the case of the collapse or moving of the ground, there are no cracks or fractures as with rigid pipes made of other materials.

TABLE 1:  
CLASSIFICATION OF PE MATERIALS

Materials TYP	MRS (MPa) The minimum strength required	$\sigma_s = MRS/C$ (MPa) Permissible tension
PE 80	8,0	6,3
PE 100	10,0	8,0
PE 100 RC <sup>PLUS</sup>	10,0	8,0

TABLE 2:  
CORRELATION BETWEEN SDR AND S

SDR	S	Working pressure »p« (bar)		
		PE 80	PE 100	PE 100 RC PLUS
17	8	8	10	10
13,6	6,3	10	12,5	12,5
11	5	12,5	16	16

All fittings and fasteners, which are mutually butt-welded are made of PE 80 (for pipes made of PE 80) or from PE 100 (for pipes made of PE 100).

LEGEND OF MARKS

SDR = standard dimension ratio  
e = thickness of the wall of the pipe (mm)  
d = pipe outer diameter (mm)  
d1 = the inner diameter of the pipe (mm)  
S = pipe series

$$SDR = d/e$$

$$S = (SDR - 1)/2$$

$$e = d/(2S + 1)$$

Permissible stress  $\sigma_s$  is calculated using the values for the IAS and the minimum project safety factor (C). In accordance with DIN EN 12201-1 / 2 it is C = 1.25. According to DIN ISO 4427 and DIN EN 12201 pressure stages are provided, as shown in Table 2.



TABLE 3: PIPES MADE OF PE 80

d (mm)	6 bar (SDR 21)	8 bar (SDR 17)	10 bar (SDR 13,6)	12,5 bar (SDR 11)	16 bar (SDR 9)
	e (mm)	e (mm)	e (mm)	e (mm)	e (mm)
20				2,0	2,3
25			2,3	2,3	3,0
32		2,0	2,4	3,0	3,6
40	2,0	2,4	3,0	3,7	4,5
50	2,4	3,0	3,7	4,6	5,6
63	3,0	3,8	4,7	5,8	7,1
75	3,6	4,5	5,6	6,8	8,4
90	4,3	5,4	6,7	8,2	10,1
110	5,3	6,6	8,1	10,0	12,3
125	6,0	7,4	9,2	11,4	14,0
140	6,7	8,3	10,3	12,7	15,7
160	7,7	9,5	11,8	14,6	17,9
180	8,6	10,7	13,3	16,4	20,1
200	9,6	11,9	14,7	18,2	22,4
225	10,8	13,4	16,6	20,5	25,2
250	11,9	14,8	18,4	22,7	27,9
280	13,4	16,6	20,6	25,4	
315	15,0	18,8	23,2	28,6	
355	16,9	21,1	26,1	32,2	
400	19,1	23,7	29,4	36,4	
450	21,5	26,7			
500	23,9	29,7			
630	30,0	37,4			

TABLE 4: PIPES OF PE 100 AND PE 100 RC PLUS

d (mm)	6 bar (SDR 26)	8 bar (SDR 21)	10 bar (SDR 17)	12,5 bar (SDR 13,6)	16 bar (SDR 11)	20 bar (SDR 9)
	e (mm)	e (mm)	e (mm)	e (mm)	e (mm)	e (mm)
20					2,0	2,3
25				2,3	2,3	3,0
32			2,0	2,4	3,0	3,6
40		2,0	2,4	3,0	3,7	4,5
50	2,0	2,4	3,0	3,7	4,6	5,6
63	2,5	3,0	3,8	4,7	5,8	7,1
75	2,9	3,6	4,5	5,6	6,8	8,4
90	3,5	4,3	5,4	6,7	8,2	10,1
110	4,2	5,3	6,6	8,1	10,0	12,3
125	4,8	6,0	7,4	9,2	11,4	14,0
140	5,4	6,7	8,3	10,3	12,7	15,7
160	6,2	7,7	9,5	11,8	14,6	17,9
180	6,9	8,6	10,7	13,3	16,4	20,1
200	7,7	9,6	11,9	14,7	18,2	22,4
225	8,6	10,8	13,4	16,6	20,5	25,2
250	9,6	11,9	14,8	18,4	22,7	27,9
280	10,7	13,4	16,6	20,6	25,4	
315	12,1	15,0	18,8	23,2	28,6	
355	13,6	16,9	21,1	26,1	32,2	
400	15,3	19,1	23,7	29,4	36,4	
450	17,2	21,5	26,7			
500	19,1	23,9	29,7			
630	24,1	30,0	37,4			

Also available in other pressure levels

 AVAILABLE BY ARRANGEMENT

## PE 80

Smaller diameter pipes (up to max. d 125 mm) are generally supplied in coils, and are mainly used for the implementation of house connections and distribution lines. Since these are highly branched and often change direction, they need to be made of a very flexible material or pipe. In this case, it is the most appropriate to use PE 80.

## PE 100, PE 100 RC PLUS

The main supply lines, which connect the place of the preparation of water with the distribution networks, are generally implemented with pipes made of PE 100. The PE 100 is a logical continuation of the development, which has enabled an increased usefulness of PE systems. A higher strength of the material gives us the possibility to produce pressure pipes of larger diameters. These pipes are usually available in bars of 12 meters and more.

## WELDING AND JOINING

Pipes, made of PE, are most commonly welded with the well known procedures: butt welding or electro - fusion welding, whereby standard PE fittings are used. The pipes can also be joined mechanically with iJOINT couplings (up to 63), toothed couplings (from 63 to 160), PE/PVC couplings (from 63 to 315) and Multi/Joint couplings (from 50 to 630).



○ PE PIPES WITH PROTECTIVE SHEATH

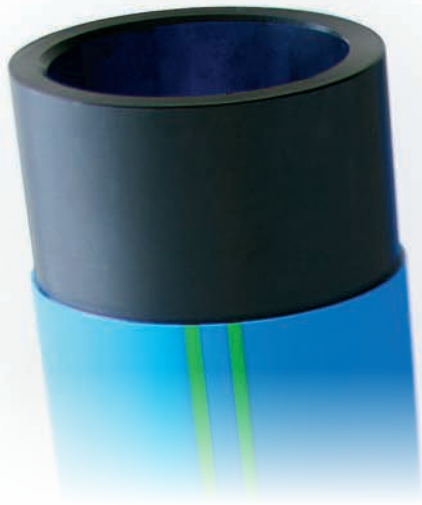

## ☉ PE PIPES WITH PROTECTIVE SHEATH

### DESCRIPTION

---

The modern and increasingly rapid way of life is also reflected in even shorter implementation deadlines set for the construction companies for the execution of individual construction projects.

Due to this it often happens that the construction workers do not pay enough attention to optimum installation conditions prescribed by the manufacturers of building materials. This kind of problem was very acute in the installation of piping systems, which pushed manufacturers to think about the creation of a product that is more resistant to errors in the installation itself, and which would, consequently, of course, increase the quality and safety of the facility. Based on these considerations, we have developed a special application of the pipelines, which can be used for distribution of water, gas and sewage, namely pipes, which are made from modern PE 100 RCplus materials, resistant to rapid crack propagation, and also pipes, which, in addition to basic polyethylene (PE) layer, have the protective layer added. Such piping greatly increases the safety of the facility in cases where the installation itself has not been carried out in accordance with building regulations.

### ADVANTAGES:

---

- saving in construction work - sand bed is not needed
- coat added materials, which cause additional strength of the protective layer - extremely resistant to abrasion
- easy separation of the layer from the base pipe

### FEATURES:

---

- dimensional range of 63-125 mm,
- SDR 11 and SDR 17,
- standards SIST EN 12201, SIST EN 1555 and S I S T EN13244,
- packaging: reels and rods,
- service life of over 100 years.

## APPLICATION:

- for water supply, gas and sewer networks,
- more demanding areas of installation, such as rocky terrain,
- underground horizontal directional drilling,
- ideal for the rehabilitation of pipelines for trenchless methods (re-lining and burst-lining),
- for projects that require quick and easy technology of laying pipes,
- in areas where the soil is contaminated.

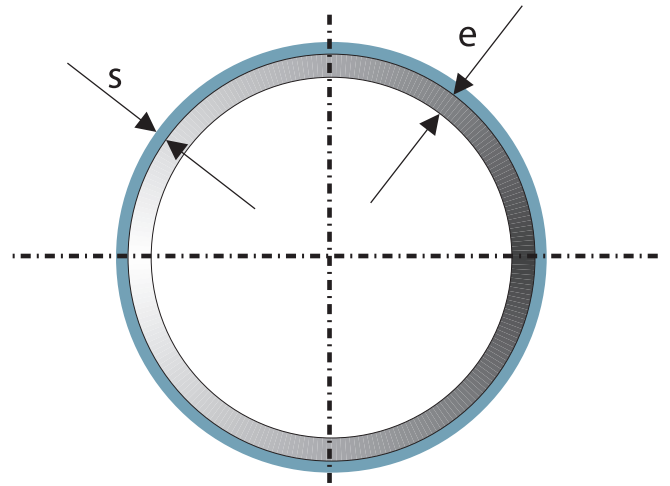
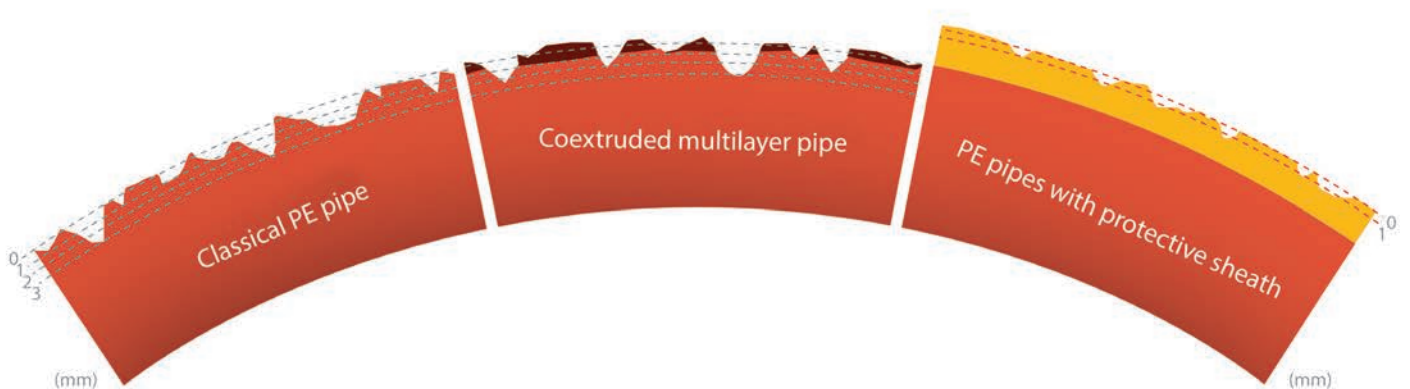

TABLE 1

Pipe diameter (mm)	SDR 11 e (mm)	SDR 17 e (mm)
32	3,0	2,0
40	3,7	2,4
50	4,6	3,0
63	5,8	3,8
75	6,8	4,5
90	8,2	5,4
110	10,0	6,6
125	11,4	7,4

s = thickness of the protective layer in all pipes is 1.5 mm





## SPECIAL INSTALLATION METHODS:

Polyethylene pipes made from material PE 100 RCPlus (resistance to crack - resistance to rapid spread of cracks) can be laid without preparing a sandy bed. Polyethylene pipe with protective sheath are particularly suited to the specific installation methods for pipelines, trenchless methods. The trenchless technique of laying requires more strict criteria for tubing.

The primary pipe with dimensions according to the requirements of the standard BS EN 12201, BS EN 1555 and BS EN 13244, can withstand loads due to internal pressure. The additional protective layer is made of polypropylene or polyethylene, reinforced with minerals, which is extremely resistant to abrasion and protects the primary pipe from damage.

### Burst-lining

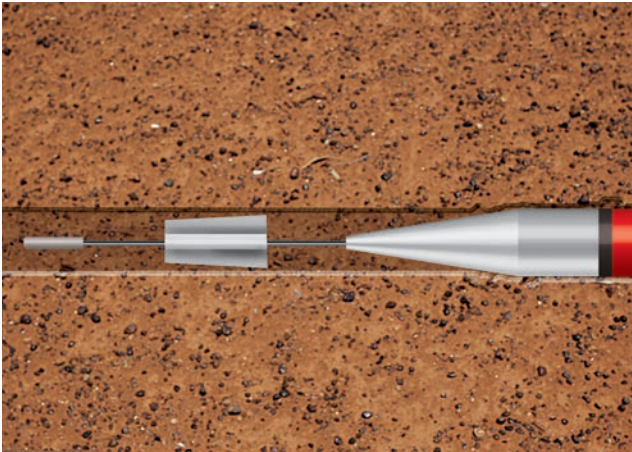

### Re-lining



### Drilling

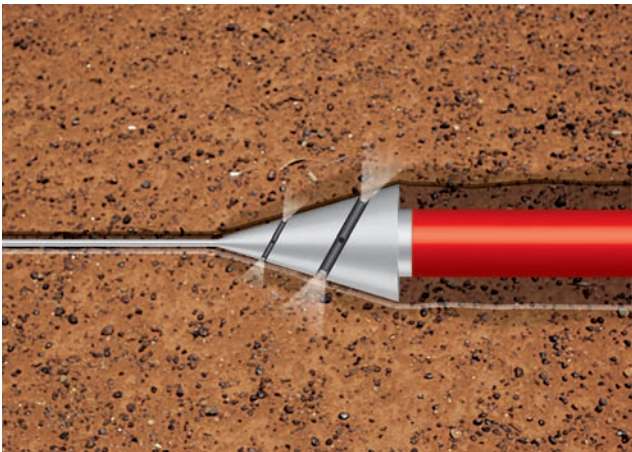

### Soil displacement

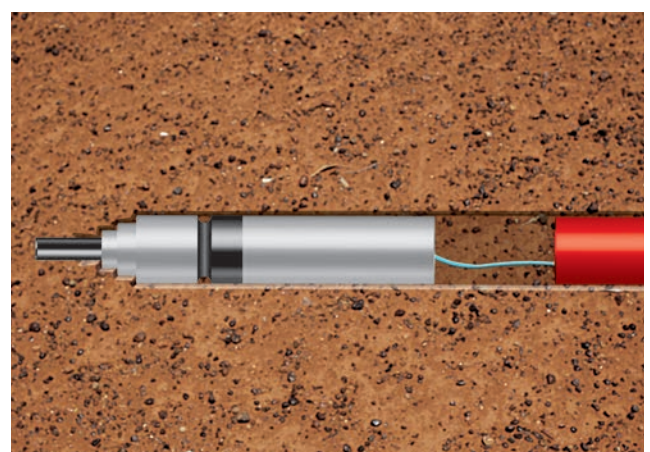



 PE PIPES FOR SEWERAGE

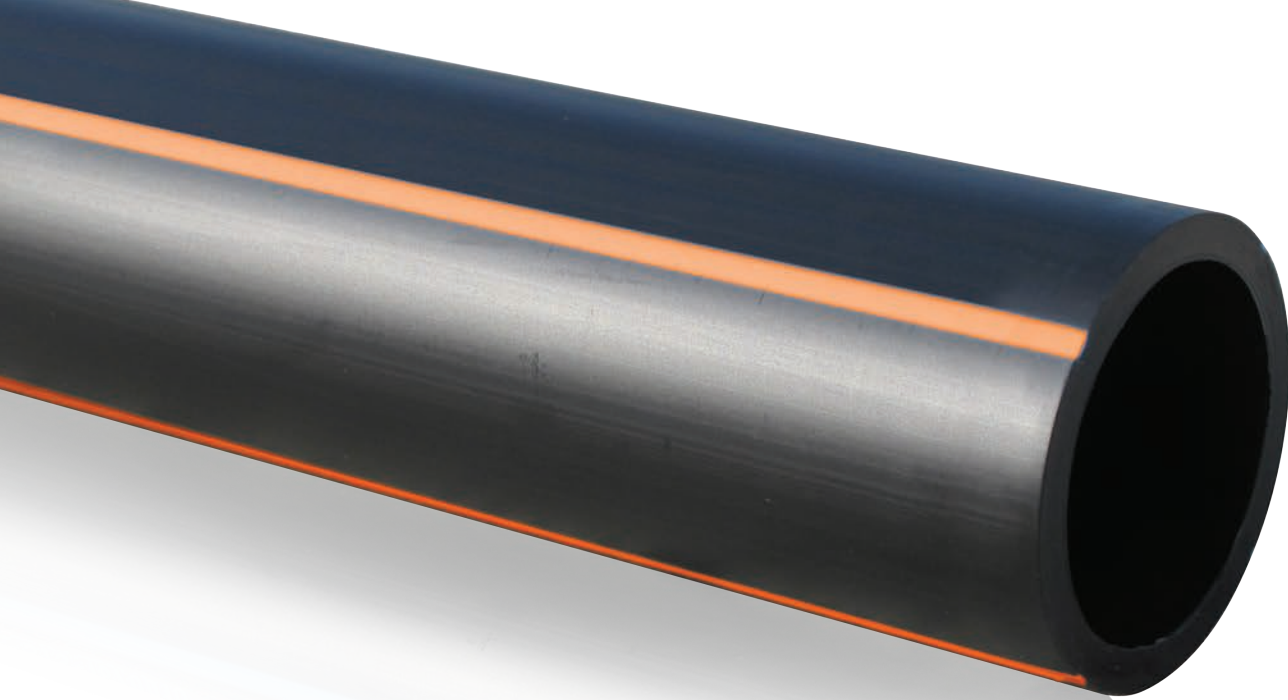

## 🌊 PE PIPES FOR SEWERAGE

### USAGE AND DESCRIPTION

---

With the constant increase of production as well as consumption of human resources, the world is facing a huge problem - where and how to discharge wastewater. This is particularly true nowadays, when the world is working hard to maintain clean environment. It has been shown that in order to achieve this, the watertight ducts are indispensable for the local or regional treatment plants. In the manufacturing of sewer pipes and fitting elements, as required by modern techniques in order to provide economical, simple and secure solutions, the use of polyethylene is irreplaceable. Pipes made of polyethylene meet all those requirements. Their use in sewer wastewater in industrial sewers (aggressive sewage), in renovating old existing sewerage network in urban centres and, of course, in renovating of dirt saturated lakes is absolutely reliable.

The watertight drainage is also needed in the construction of individual houses or commercial buildings in villages and towns. In many cases the drinking water is still pumped from wells and the sewage, which is not waterproof, and poses a major risk for the population.

### ADDITIONAL ADVANTAGES OF PE PIPES:

---

- available in rolls and bars of 12 meters or longer,
- low weight,
- easy and quick to install,
- large flow capacity
- chemical resistance,
- cheap and easy transportation,
- multi-purpose technique effluents.

### TECHNICAL INFORMATION

---

The necessary wall thickness of the pipe in the sewer pipes without the pressure is determined depending on the external load, e.g. earth pressure and traffic. Since the plastic materials tend to creep, the deformation increases with time.

There are two types of deformation: short-term and long-term deformation. Polyethylene pipes must be dimensioned in such a way that after 50 years the long-term deformation shall not be more than 6%. Calculation of polyethylene pipes without pressure, which are laid in the ground, is carried out according to ATV - Worksheet A 127: Guidelines for the calculation of static channels and drainage lines.

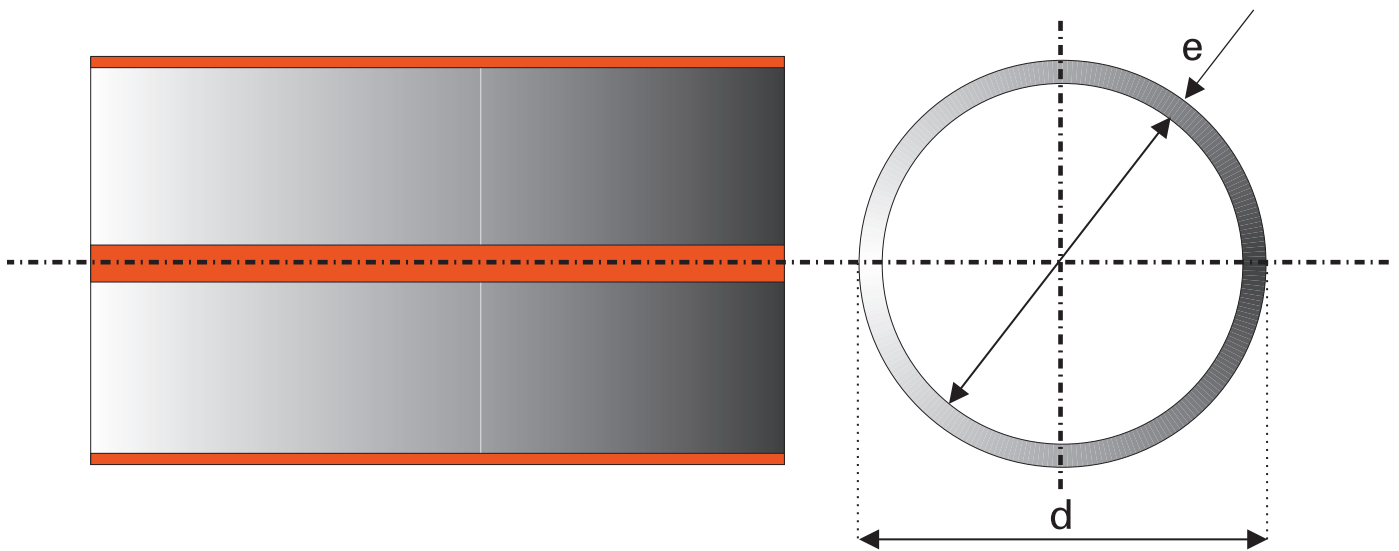

e = thickness of the wall of the pipe (mm)  
d = pipe outer diameter (mm)  
d1 = the inner diameter of the pipe (mm)

The pipes are in accordance with the standards EN 12201, EN 12666 and ISO 8772 for pressurized or unpressurized water.

TABLE 4: PE 100 AND PE 100 RC<sup>PLUS</sup> PIPES

d (mm)	10 bar (SDR 17)	16 bar (SDR 11)
	e (mm)	e (mm)
63	3,8	5,8
75	4,5	6,8
90	5,4	8,2
110	6,6	10,0
125	7,4	11,4
140	8,3	12,7
160	9,5	14,6
180	10,7	16,4
200	11,9	18,2
225	13,4	20,5
250	14,8	22,7
280	16,6	25,4
315	18,8	28,6
355	21,1	32,2
400	23,7	36,4
450	26,7	
500	29,7	
630	37,4	

Also available in other pressure levels

 AVAILABLE BY ARRANGEMENT





PE PIPES FOR GAS DISTRIBUTION

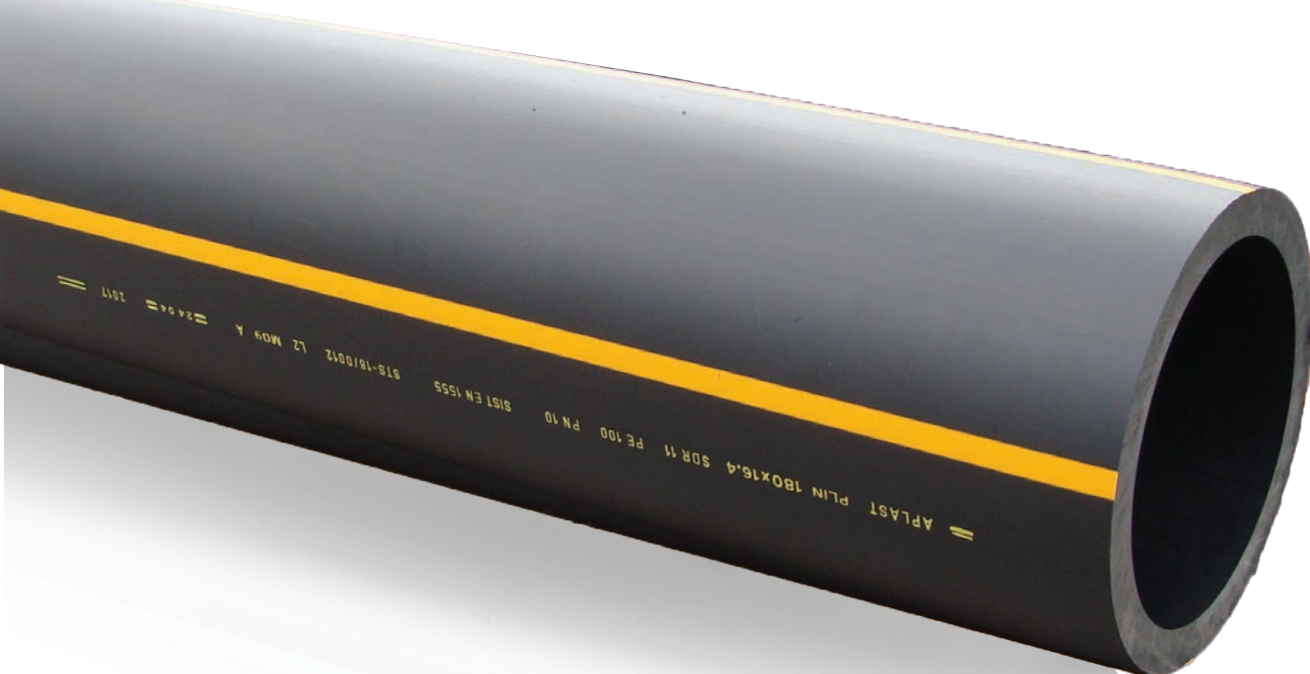

## PE PIPES FOR GAS DISTRIBUTION

### DESCRIPTION

---

Polyethylene (PE) is a material, which offers a series of clear advantages when compared to traditional materials, used for gas distribution pressure pipes.

Due to exceptionally good technical properties of polyethylene, the system of pipes and connecting elements represents an ideal synthesis of reliability and economy and is the optimal choice for the construction of low and medium pressure gas distribution grid.

Characteristics of PE:

Material classification (MRS) >10

Specific material mass: > 950kg/m<sup>3</sup>

Flow rate 190°/5kg(MFR): 0,2-0,6 g/10min

### ADVANTAGES

---

- high flexibility and possibility of delivery in rolls (DN 20mm-125mm), due to which fewer connections are needed, laying is simpler and quicker, or in bars 6 or 12m up to DN450mm,
- lower installation and maintenance costs,
- low specific mass makes them easy to handle and reduces transport costs,
- exceptional chemical resistance enables laying in aggressive ground,
- long life expectancy.

PE gas distribution pipes are made of PE100 material for working pressure of up to 4 bar or up to 10 bar.

The pipes are black with yellow lines along their length. Every meter of length is marked with a visible and permanent marking. Smooth surface enables maximum flow of medium through the system.

Pipe control is carried out during regular production and in a modernly equipped laboratory according to the requirements of the Slovenian Technical Approval STS 16/0012 and Standard SIST EN 1555.

Construction Institute of Slovenia (ZAG) checks compliance with STS annually.



**Zavod za gradbeništvo Slovenije**  
Slovenian National Building and Civil  
Engineering Institute

Dimičeva 12  
1000 Ljubljana, Slovenija  
Tel.: +386 (0)1-280 44 72, 280 45 37  
Fax: +386 (0)1-280 44 84  
E-pošta: info.ta@zag.si  
http://www.zag.si



ozn.: S-01485/16

## Slovensko tehnično soglasje STS-16/0012

Slovenian Technical Approval

Podeljeno na podlagi določil **Zakona o gradbenih proizvodih – ZGPro-1** (Ur. list RS, št. 82/2013) naslednjemu gradbenemu proizvodu:

On the basis of provisions of the *Construction Products Act – ZGPro-1* (OG RS, nos. 82/2013) granted to the following construction product:

**Komercialno ime proizvoda:** PE cevi APLAST za razvod plina - oplaščene s PPZ, PE-RC ali neoplaščene cevi  
*Aplast PE pipes for gas supply - coated with PPZ, PE-RC or uncoated pipes*

**Imetnik soglasja:** Aplast d.o.o.  
*Holder of approval* Petrovčeve 115a  
3301 Petrovče

**Vrsta in predvideni namen uporabe proizvoda:** Polietilenske plinske cevi z nazivnimi premeri DN 20-450 mm, standardnimi dimenzijskimi razmerji SDR 11 ali 17 in tlačnimi razredi PN do 10 bar.  
Polietilenske plinske cevi z zaščitno zunanjo plastjo iz polipropilena ali polietilena, nazivnih premerov DN 32-125 mm, standardnih dimenzijskih razmerij SDR 11 ali 17 in tlačnih razredov PN do 10 bar za razvod plina.  
*Polyethylene gas pipes with nominal diameters DN 20-450 mm, standard dimensional ratios SDR 11 or 17 and pressure classes PN up to 10 bar.*  
*Polyethylene gas pipes with protective outer layer of polypropylene or polyethylene, with nominal diameters DN 32-125 mm, standard dimensional ratios SDR 11 or 17 and pressure classes PN up to 10 bar.*

*Generic type and use of the product*

**Veljavnost:** od (from) 12. 12. 2016  
*Validity* do (to) 11. 12. 2021

**Proizvodni obrat:** Aplast d.o.o.  
*Manufacturing plant* Obrat Ložnica pri Žalcu 37  
3310 Žalec

To Slovensko tehnično soglasje obsega: 24 strani vključno 5 prilogami  
*This Slovenian Technical Approval contains* 24 pages including 5 annexes



Obr. P.U.10-001-7/8



$$SDR = d/e \text{ (ISO 4437)}$$

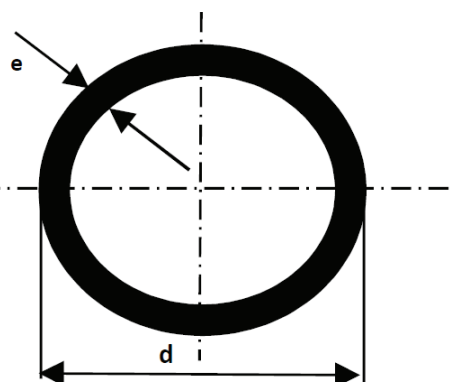

d = external diameter of the pipe  
e = wall thickness



TABLE 1: PIPES PE100 FOR GAS LINES

d (mm)	4 bar (SDR 17)	10 bar (SDR 11)
	e (mm)	e (mm)
20		3,0
25		3,0
32		3,0
40		3,7
50		4,6
63	3,8	5,8
75	4,5	6,8
90	5,4	8,2
110	6,6	10,0
125	7,4	11,4
140	8,3	12,7
160	9,5	14,6
180	10,7	16,4
200	11,9	18,2
225	13,4	20,5
250	14,8	22,7
280	16,6	25,4
315	18,7	28,6
355	21,1	32,3
400	23,7	36,4
450	26,7	



# WELDING AND JOINING

Coupling with frontal welding



Joint with electro-fusion coupler



The junction with toothed coupling



Moulded coupling elements made of PE and ductile cast iron



Coupling with iJOINT coupling for PE pipes



The junction with the Multi / Joint 3007 Plus Coupler



Coupling with PVC / PE coupler



The materials installed around the pipeline should allow lasting stability and taking over of the load in the zone of the pipeline in the ground, and should not affect the pipe material. Backfilling in the pipe zone area, including the zone beds, with the side filling and overlay zone is carried out according to the guidelines of DIN 4033 and DIN EN 1610.





APLAST proizvodnja in trgovina d.o.o.  
Petrovče 115a, 3301 Petrovče, Slovenija  
[www.aplast.si](http://www.aplast.si) | [info@aplast.si](mailto:info@aplast.si)



**YOUR RETAILER:**